

SA01CC

Standard SpaceArm Single Hub C-Clamp
 US Patent: 6,695,270 B1 6,758,454 B2 7,316,377 B2

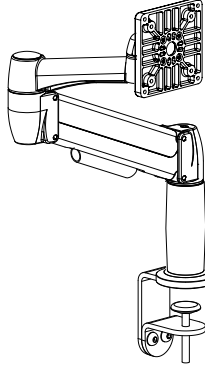

Required Tools:

- 17 mm Socket
- 5mm Allen Key (Included)
- #2 Phillips Screwdriver

Contents:

#	QTY	Part Name
1	02	sm M10 Screw
2	01	C-Clamp Bottom Bracket
3	01	C-Clamp Baseplate
4	01	Single Hub
5	01	M10 Washer
6	01	M10 Bolt
7	04	Plastic Washer
8	08	Monitor Screws
9	01	Standard SpaceArm

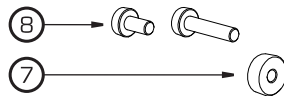
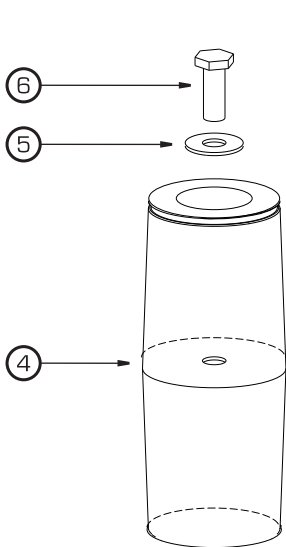

Monitor Mounting

Hardware package includes both short and long screws and plastic washers.

The long screws & plastic washers should be used for recessed monitor mounts.

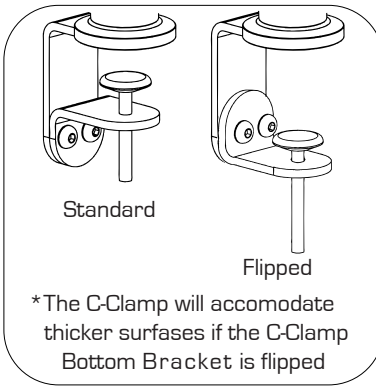

Adjusting Counter Balance
 *Required Tool: 5mm Allen Wrench

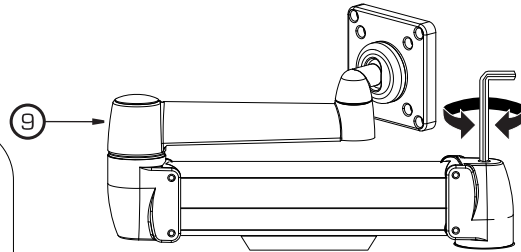

Position Arm so it is parallel to desk surface.
 Turn bolt clock wise for lighter monitors.

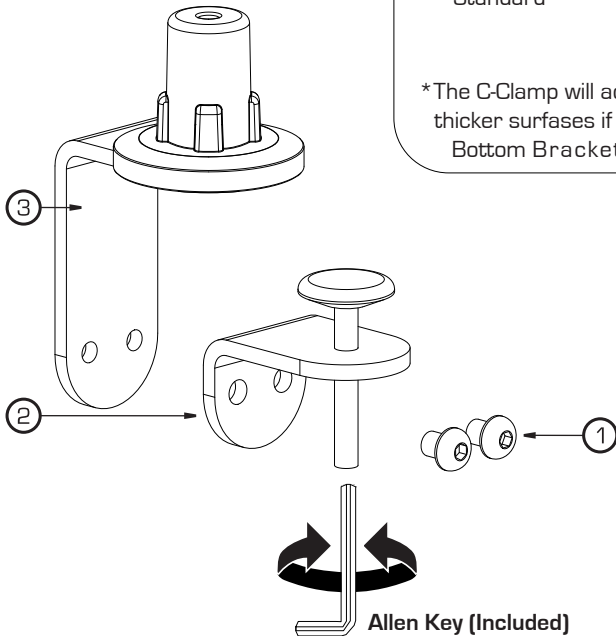

Cable Routing

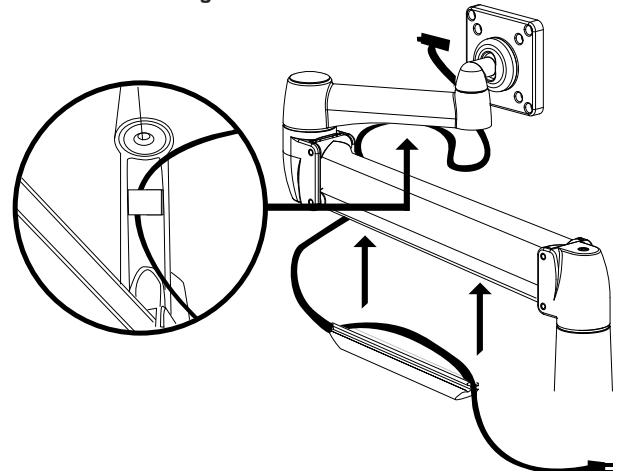

SpaceCo Business Solutions, Inc. 800.840.8499 www.spaceco.com

DISCLAIMER OF DAMAGES FOR IMPROPER USE. SpaceCo shall not be responsible for damage to its products, or injuries or damages caused by its products, resulting from improper installation, maintenance, unintended use or attempts to operate such products beyond their mechanical capacity, intentionally or otherwise, or by reason of unauthorized repair. May be covered by issued or pending patents, please see www.spaceco.com/patents for details.